

# A Novel Biomimetic Stimulator System for Neural Implant

Po-Min Wang<sup>1</sup>, Stanislav Culaclii<sup>1</sup>, William Yang, Yan Long, Jonathan Massachi, Yi-Kai Lo, and Wentai Liu

**Abstract**— Electrical stimulation using non-periodic biomimetic stimulation pattern has been shown to be effective in various critical biomedical applications. However, the existing programmable stimulators that support this protocol are non-portable and have architectures that are not translatable to wearable or implantable applications. In this work, we present a 32-channel neural stimulator system based on an implantable System-On-Chip (SoC) that addresses these technological challenges. The system is designed to be portable, powered by a single battery, wirelessly controlled, and versatile to perform concurrent multi-channel stimulation with independent arbitrary waveforms. The experimental results demonstrate multi-channel stimulation mimicking electromyography (EMG) waveforms and randomly-spaced stimulation pulses mimicking neuronal firing patterns. This compact and highly flexible prototype can support various neuromodulation researches and animal studies and serves as a precursor for the development of the next generation implantable biomimetic stimulator.

## I. INTRODUCTION

Electrical neural stimulation is an effective method of modulating nervous systems for the purposes of therapeutics and research of neurologic diseases. Typical neural stimulation involves delivery of periodic electrical current to the tissue at predefined times and spans. This has been shown to be useful in deep brain stimulation (DBS) therapy for treating motor disorders due to Parkinson’s disease [1], rehabilitation after spinal cord injury to restore motor functions [2], epiretinal prosthesis to enable vision for the blind [3], etc. Recently it has also been demonstrated that non-periodic, non-uniform stimulation is more effective in these applications. For example, a stimulus pattern mimicking a pre-recorded EMG signal is more effective in activating spinal cord locomotion circuits compared to uniformly periodic protocol [4]. In addition, neuromodulation using non-regularly timed stimuli for DBS has produced better therapeutic effects for treating Parkinson’s [1]. Finally, stimuli timed with a random exponential distribution prevent adaptation of retinal ganglion cells, promising to reduce undesired image “fading” effect in epiretinal prosthesis [5].

Such biomimetic stimulation patterns require a sophisticated stimulator solution. The most common approaches use bulky stimulators which can mimic a preloaded waveform, e.g. computer with a data acquisition (DAQ) device [1] or desktop stimulator [6]. These commercial devices are not translatable to either implantable application or a responsive system which can adjust its stimulation based on the bio-recordings in real-time. A few implantable and programmable neural stimulators, demonstrated previously, [7, 8] can adjust their pulse widths and firing frequencies, or turn on or off based on external commands. Yet they lack the ability to adapt the amplitude of each stimulation parameter in real-time and are thus unable to mimic the biological signal waveforms.

This work presents an implementation of a *biomimetic stimulator* platform that is based on a wireless SoC [9], which can be advanced to an implantable, real-time closed-loop, bidirectional system capable of biomimetic stimulation for various applications (Fig. 1). This prototype provides a

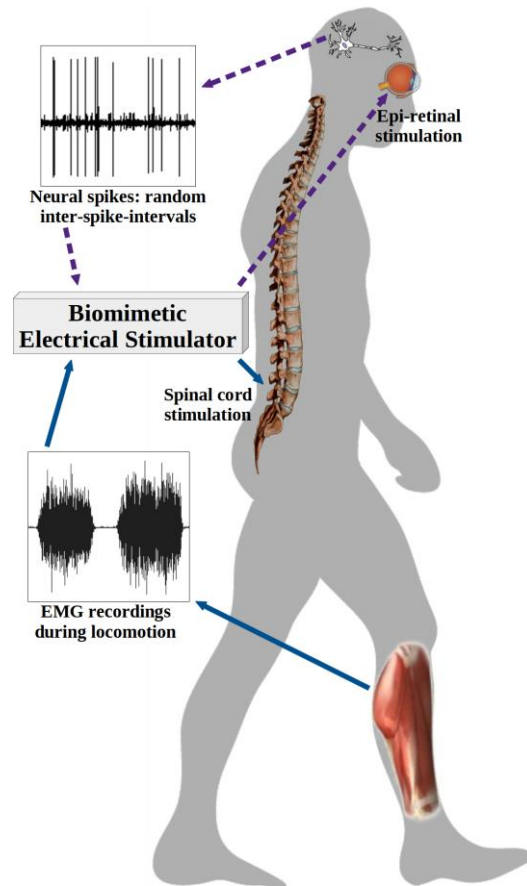

Figure 1. Conceptual diagram demonstrating applications of a next-generation biomimetic stimulator.

\*This project is partially supported by NIH BRP U01 EB007615 and National Science Foundation Award 1647917.

P.-M. Wang, S. Culaclii, Jonathan Massachi, and W. Liu are with the Department of Bioengineering, University of California, Los Angeles, CA, 90095, USA (e-mails: pominwang@g.ucla.edu, stanislav.c@ucla.edu, jmassachi@ucla.edu, wentai@ucla.edu).

W. Yang is with the Department of Computer Science, University of California, Los Angeles, CA, 90095, USA (e-mail: will.yang1247@gmail.com).

Y. Long is with the College of Electrical Engineering, Zhejiang University, Hangzhou, 310027, China (e-mail: real.yanlong@gmail.com)

Y.-K. Lo is with Niche Biomedical Inc., Los Angeles, CA 90095, USA (e-mail: yikai@nichebio.com).

<sup>1</sup>Both authors contributed equally to this work.

reliable, battery-powered platform for evaluation of biomimetic stimulation therapy on animal models. The future experimental results with the prototype will also be used to enhance our existing wireless implant system for biomimetic stimulation mode.

## II. DESIGN OF THE BIOMIMETIC WAVEFORM STIMULATOR

### A. System Architecture

The biomimetic-waveform stimulator is designed to support features of portability, single battery power, wireless user interface, user-defined arbitrary stimulation patterns, and concurrent multi-channel stimulation. The system block diagram of this stimulator is shown in Fig. 2. The core of the stimulator is our custom-developed stimulator SoC [9]. The clock and commands required by the SoC for generating the stimulation output are sent from a control unit through wire connection. The SoC notably also supports wireless power and data transmissions via telemetry coils, which allow the stimulation system to support implantable applications as needed. The control unit is then wirelessly configured by the User Interface (UI) in a mobile device through a WiFi link. The UI allows the researchers to define stimulation patterns tailored for the targeted biomedical application. The supply voltages of the SoC and the control unit are generated by a power supply unit whose input power source is a single 3.7 V lithium-ion battery.

It is worthy to note that this proposed system design not only achieves a highly flexible and compact stimulation-platform technology but also considers the design requirement for upgrading to the next generation real-time closed-loop system, which will include simultaneous recording and stimulation. For example, WiFi communication protocol is selected instead of Bluetooth because its high data rate can support more channels of wireless recording. In addition, the battery-powered scheme eliminates the potential 60 Hz noise issue, which increases signal fidelity in the recording circuitry.

### B. System Logic Design for Biomimetic Stimulation

The system's logic architecture is designed to allow direct control of amplitude and width of each individual current pulse and their timing within the desired output waveform driven by the stimulator's SoC. This ultimately enables unique dynamic stimulation patterns such as random pulse periods and biomimetic waveform generation on multiple stimulation output channels. The logic is designed to be fully compatible with the data protocol of existing stimulator SoC design [9].

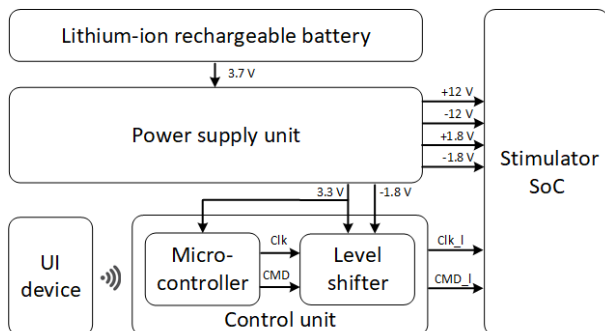

Figure 2. Functional diagram of the implemented biomimetic stimulator.

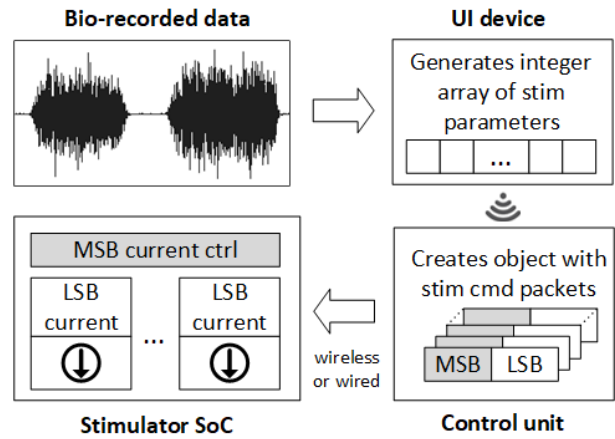

Figure 3. Logic flow diagram shows the sequence of control logic distributed between three main modules of the system.

This control logic is distributed across the three major components shown in Fig. 3: the software app code in the UI device, the firmware code executed by the microcontroller in the control unit and digital very-large-scale integration (VLSI) circuit in the SoC. The logic architecture places more computational demand on the former two components of the system while least computational logic resides in the SoC's digital controller allowing it to have small size and power consumption, thus reducing invasiveness in implantable applications. In contrast to our previous work [10], the new logic architecture generates a unique data packet in real-time in response to the required stimulation parameters for each individual stimulus instance.

When using the system for stimulating with a pre-recorded biomimetic signal, the UI device is programmed by user with a CSV file describing the desired signal waveform. This waveform is transferred as a set of integers to the control unit. The control unit constructs a full data packet from integers for each data point, where the data packet defines the stimulation parameters in the format required by the stimulating SoC. This format includes most significant bit (MSB) and least significant bit (LSB) bit groups which define the stimulation pulse width and amplitude for each channel. As the packet for each stimulus data point is created it is immediately sent to the SoC in real-time. The SoC's digital controller configures internal registers with the bits from the data packet received and fires the stimulus current pulses in each channel accordingly. The process repeats at the predefined stimulation sample rate of the desired biomimetic stimulus waveform.

When the system is used to enable stimulation with randomized Inter-Pulse-Intervals (IPI), the user enters the average required stimulation IPI into UI device. The device generates an array of IPI following an exponential distribution with the required average following the equation:

$$T_n = \ln(U) / \lambda \quad (1)$$

where  $T_n$  is the pulse period for the n-th pulse,  $U$  is uniform probability distribution in range [0, 1], and  $\lambda$  is the desired mean of IPI. An array containing the parameters of the stimulation current pulses and the randomized IPI values are then sent to the control unit. The remaining control logic flow is the same as that of the biomimetic stimulation.

### C. Power Supply Unit

The power supply unit translates the 3.7 V battery into five different voltages to power the system. The unit is constructed by an off-the-shelf DC-to-DC converter and low dropout voltage regulators manufactured by Analog Devices (Norwood, MA). The DC-to-DC converter (ADP5070) generates  $\pm 15V$  simultaneously from the battery. The  $\pm 15V$  are then translated to  $\pm 12V$  to supply the SoC by ADP7142 and ADP7182 regulators, respectively. In order to ensure the symmetry between  $\pm 1.8V$ , they are generated from  $\pm 12V$  through other ADP7142 and ADP7182 regulators. The 3.3 V for the control unit is directly regulated from the battery by ADP7158 regulator to avoid extra power loss.

### III. EXPERIMENTAL RESULTS

Fig. 4 shows a photo of the proposed biomimetic stimulator prototype with a size of  $14 \times 10 \times 5.5 \text{ cm}^3$ . The SoC is packaged in a QFP package to interface with the peripheral electronics. Bench top tests are conducted to demonstrate the versatile waveforms generated by the stimulator, including randomized period pulse train for retinal stimulation applications and EMG-mimetic stimulation pattern for spinal cord stimulation. During testing, the stimulator is wirelessly controlled by an App in an Android tablet through the WiFi link. Each stimulation output channel is connected to a  $10 \text{ k}\Omega$  resistive load.

A demonstration of the randomized period pulse train is shown in Fig. 5. The resulting multi-channel pulse trains exhibit random IPI which follows an exponential random distribution and has been shown to reduce undesired neural adaptation in epiretinal stimulation [5]. The mean period is 30 ms with current amplitudes set to 0.5 mA and pulse width set between 1 and 4 ms among the available channels. This specific application only requires one random IPI pattern, but does not impose a requirement for relative timing between multiple channels. Yet the presented logic design supports randomness in relative timing between channels if needed.

Fig. 6 demonstrates the stimulator's ability to generate a biomimetic waveform. Fig. 6 (a) shows two signals with a desired stimulation waveform based on a EMG recordings from the tibialis anterior (TA) of a rat during stepping. Fig. 6 (b) shows the corresponding EMG-mimetic output generated

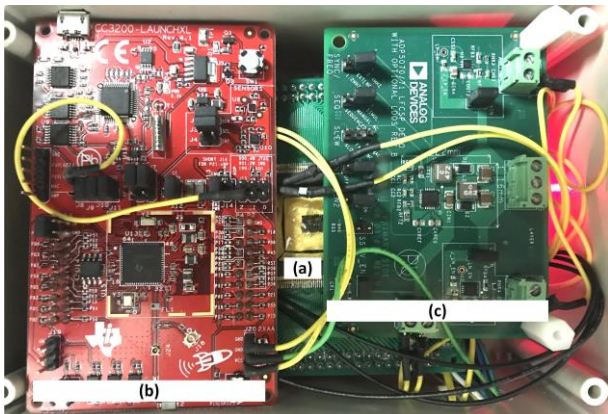

Figure 4. Physical implementation of the portable biomimetic stimulator: (a) our QFP-packaged SoC, (b) microcontroller in the control unit, and (c) part of the power supply unit. Other parts in the system are arranged below those three components.

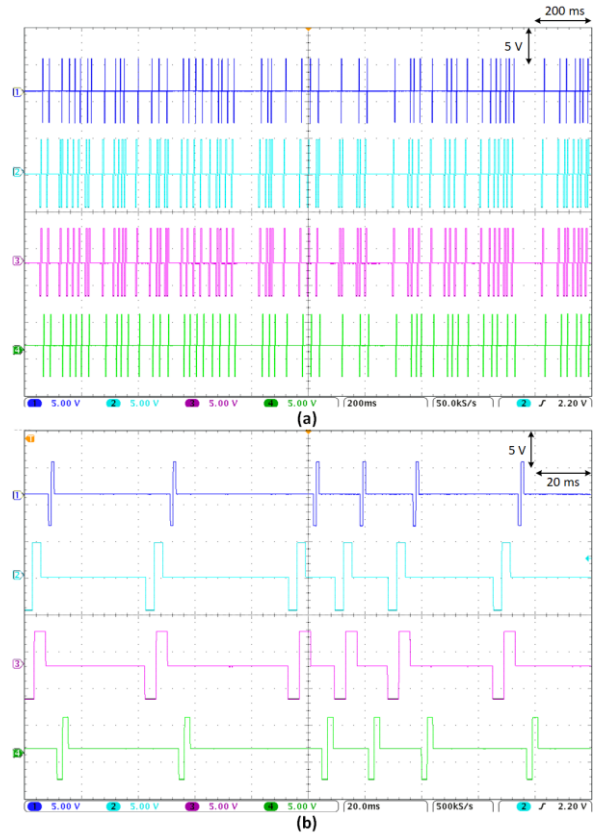

Figure 5. (a) Measured multi-channel simulation with random IPI following exponential random distribution. Each stimulation channel has a mean IPI of 30 ms and an output current of  $500 \mu\text{A}$ . (b) Magnified view shows the different pulse widths and start delays among different channels.

by the stimulator. The resolution of the output current amplitude supported by the SoC is 4 bits (digital-to-analog converter) + 3 bits (variable-gain current mirror) [11]. The temporal resolution of this example's waveform is  $500 \mu\text{s}$ , measured from the start of one pulse to the next one. Within this period there is a  $100 \mu\text{s}$  gap with a null output, which appears between each two consecutive current samples in Fig. 6(b). This gap is required to transmit a command from the control unit to the SoC's digital controllers and process it by the controller. We hypothesize that the presence and the exact length of this gap will not affect the response of neural tissue as it much shorter than the refractory period of an individual neural cell, i.e. 1-2 ms [12]. The authors plan to evaluate this hypothesis by using the presented device in the future *in-vivo* study. Additionally, the gap can be eliminated by combining multiple stimulation channels with predetermined timing settings such that the gap in one channel is occupied by the current output of another. This achieves a continuous biomimetic waveform sans gap shown in Fig. 7.

One potential issue of the biomimetic stimulation, e.g. EMG-mimetic pattern, is the charge imbalance induced by non-symmetric waveform that might cause neural damage. This can be addressed by the charge cancellation switch in the SoC, which passively dissipates the accumulated charge in the electrode/tissue interface [9]. The timing of the discharge behavior can be controlled through a predetermined setting, which allows the researchers the flexibility to enable this function and tailor it for various stimulation protocols.

#### IV. CONCLUSION

This work presents a novel biomimetic stimulator system integrated with an implantable neural interface SoC. The portable system can support concurrent multi-channel stimulation output with versatile stimulation parameters. Furthermore, it can be advanced to a miniaturized wireless implantable system. Initially this prototype will be used to evaluate and improve the biomimetic stimulation efficacy in retinal stimulation, spinal cord stimulation and others. Future work also includes the development of closed-loop capability with this biomimetic stimulation system.

#### REFERENCES

- [1] D. T. Brocker, B. D. Swan, D. A. Turner, R. E. Gross, S. B. Tatter, M. M. Koop, et al., "Improved efficacy of temporally non-regular deep brain stimulation in Parkinson's disease," *Experimental neurology*, vol. 239, pp. 60-67, 2013.
- [2] S. Harkema, Y. Gerasimenko, J. Hodes, J. Burdick, C. Angeli, Y. Chen, et al., "Effect of epidural stimulation of the lumbosacral spinal cord on voluntary movement, standing, and assisted stepping after motor complete paraplegia: a case study," *The Lancet*, vol. 377, pp. 1938-1947, 2011.
- [3] J. D. Weiland, W. Liu, and M. S. Humayun, "Retinal prosthesis," *Annu. Rev. Biomed. Eng.*, vol. 7, pp. 361-401, 2005.
- [4] F. Dose, R. Menosso, and G. Taccola, "Rat locomotor spinal circuits in vitro are activated by electrical stimulation with noisy waveforms sampled from human gait," *Physiological reports*, vol. 1, 2013.
- [5] A. Soto-Breceda, T. Kameneva, H. Meffin, M. Maturana, and M. Ibbotson, "Irregularly timed electrical pulses reduce adaptation of retinal ganglion cells," *Journal of neural engineering*, vol. 15, p. 056017, 2018.
- [6] "STG4000 Series Stimulus Generators ". Available online: <https://www.multichannelsystems.com/products/stg4000-series>. Accessed 18 Dec. 2018.
- [7] "Activa RC Neurostimulator ". Available online: <http://www.medtronic.com/us-en/healthcare-professionals/products/neurological/deep-brain-stimulation-systems/activa-rc.html>. Accessed 18 Dec. 2018.
- [8] "Spectra WaveWriter™ SCS System ". Available online: <http://www.bostonscientific.com/en-US/products/spinal-cord-stimulators-or-systems.html>. Accessed 18 Dec. 2018.
- [9] Y.-K. Lo, Y.-C. Kuan, S. Culaclii, B. Kim, P.-M. Wang, C.-W. Chang, J. A. Massachi, M. Zhu, K. Chen, P. Gad, V. R. Edgerton, and W. Liu, "A Fully Integrated Wireless SoC for Motor Function Recovery After Spinal Cord Injury," *IEEE Transactions on Biomedical Circuits and Systems*, vol. 11, pp. 497-509, 2017.
- [10] J. Massachi, Y.-K. Lo, P.-M. Wang, and W. Liu, "A Wireless Platform to Support Pre-Clinical Trial of Neural Implant for Spinal Cord Injury," presented at the *2018 40th Annual International Conference of the IEEE Engineering in Medicine and Biology Society (EMBC)*, Honolulu, HI, USA, 2018.
- [11] K. Chen, Z. Yang, L. Hoang, J. Weiland, M. Humayun, and W. Liu, "An integrated 256-channel epiretinal prosthesis," *IEEE Journal of Solid-State Circuits*, vol. 45, pp. 1946-1956, 2010.
- [12] J. E. Hall, *Guyton and Hall textbook of medical physiology*: Elsevier Health Sciences, 2015.

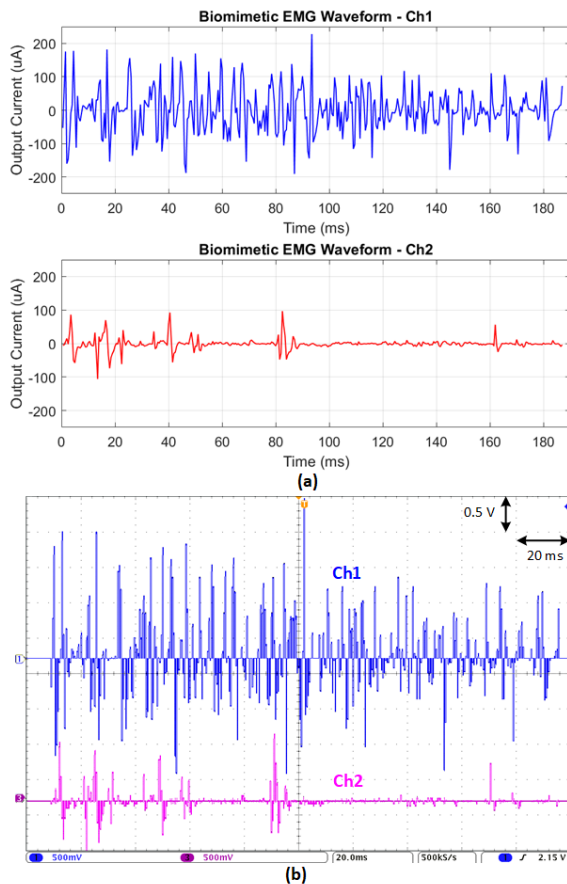

Figure 6. Bench-top demonstration of multi-channel dynamic waveform stimulation mimicking a recorded EMG waveform, which has been shown to be effective in epidural spinal cord stimulation for restoring motor function [4]. (a) Desired biomimetic stimulation waveform. (b) Output of the prototype stimulator captured with an oscilloscope.

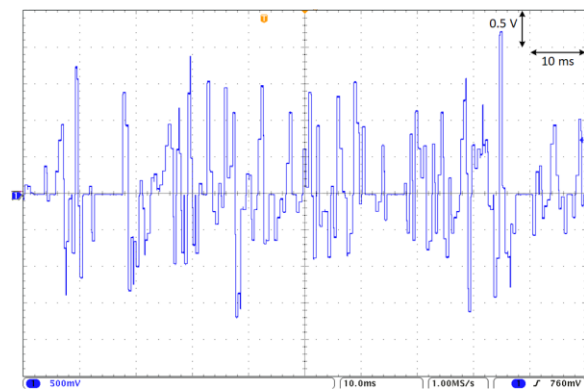

Figure 7. A continuous biomimetic current waveform is achieved by combining multiple channels together into a single output.